

# XP SERIES

# LPS89L

# LUMBER JACK

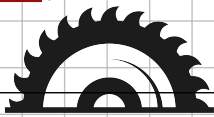

## Original Manual Mini Plunge Saw

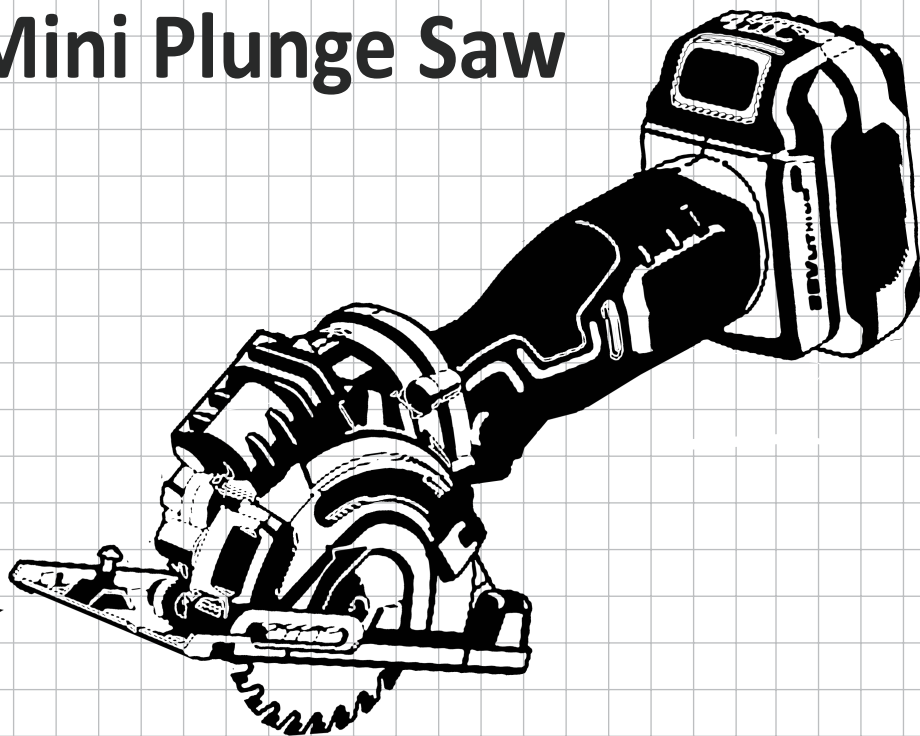

**⚠ WARNING**

Read this manual before using this product.  
Failure to do so can result in serious injury.  
**SAVE THIS MANUAL.**



## **INDEX**

---

- 1 - 3. Power Tool & Personal Safety
  - 4. Symbols & Technical
  - 5. Includes
  - 6. Assembly
  - 7. Operation
  - 8. Maintenance & Service
  - 9. Declaration
-

## General Power Tool Safety Warnings

**⚠ WARNING** : Read all safety warnings and instructions. Failure to follow the warnings and instructions may result in electric shock, fire and/or serious injury.

**Save all warnings and instructions for future reference.**

The term " power tool " in the warnings refers to your mains operated (corded) power tools or battery operated (cordless) power tools.

### 1. Work Area Safety

- a. **Keep work area clean and well lit.** Cluttered or dark areas invite accidents.
- b. **Do not operate power tools in explosive atmospheres, such as in the presence of flammable liquids, gases or dust.** Power tools create sparks which may ignite the dust or fumes.
- c. **Keep children and bystanders away while operating a power tool.** Distractions can cause you to lose control.

### 2. Electrical Safety

- a. **Power tool plugs must match the outlet. Never modify the plug in any way.** Do not use any adapter plugs with grounded power tools. Unmodified plugs and matching outlets will reduce risk of electric shock.
- b. **Avoid body contact with grounded surfaces such as pipes, radiators, ranges and refrigerators.** There is an increased risk of electric shock if your body is grounded.
- c. **Do not expose power tools to rain or wet conditions.** Water entering a power tool will increase the risk of electric shock.
- d. **Do not abuse the cord.** Never use the cord for carrying, pulling or unplugging the power tool. Keep cord away from heat, oil, sharp edges or moving parts. Damaged or entangled cords increase the risk of electric shock.
- e. **When operating a power tool outdoors, use an extension cord suitable for outdoor use.** Use of a cord suitable for outdoor use reduces the risk of electric shock.
- f. **If operating a power tool in a damp location is unavoidable, use a residual current device (RCD) protected supply.** Use of a RCD reduces the risk of electric shock.

**⚠ NOTE** :The term residual current device (RCD) may be replaced by the term ground fault circuit interrupter (GFCI) or earth leakage circuit breaker (ELCB).

### 3. Personal Safety

- a. Stay alert, watch what you are doing and use common sense when operating a power tool. Do not use a power tool while you are tired or under the influence of drugs, alcohol or medication. A moment of inattention while operating power tools may result in serious personal injury.
- b. Use personal protective equipment. Always wear eye protection. Protective equipment such as dust mask, non-skid safety shoes, hard hat, or hearing protection used for appropriate conditions will reduce personal injuries.
- c. Prevent unintentional starting. Ensure the switch is in the off position before connecting to power source and/or battery pack, picking up or carrying the tool. Carrying power tools with your finger on the switch or energising power tools that have the switch on invites accidents.
- d. Remove any adjusting key or wrench before turning the power tool on. A wrench or a key left attached to a rotating part of the power tool may result in personal injury.
- e. Do not overreach. Keep proper footing and balance at all times. This enables better control of the power tool in unexpected situations.
- f. Dress properly. Do not wear loose clothing or jewellery. Keep your hair, clothing and gloves away from moving parts. Loose clothes, jewellery or long hair can be caught in moving parts.
- g. If devices are provided for the connection of dust extraction and collection facilities, ensure these are connected and properly used. Use of dust collection can reduce dust related hazards.

### 4. Power Tool Use and Care

- a. Do not force the power tool. Use the correct power tool for your application. The correct power tool will do the job better and safer at the rate for which it was designed.
- b. Do not use the power tool if the switch does not turn it on and off. Any power tool that cannot be controlled with the switch is dangerous and must be repaired.
- c. Disconnect the plug from the power source and/or the battery pack from the power tool before making any adjustments, changing accessories, or storing

power tools. Such preventive safety measures reduce the risk of starting the power tool accidentally.

**d.** Store idle power tools out of the reach of children and do not allow persons unfamiliar with the power tool or these instructions to operate the power tool. Power tools are dangerous in the hands of untrained users.

**e.** Maintain power tools. Check for misalignment or binding of moving parts, broken parts and any other condition that may affect the power tools operation. If damaged, have the power tool repaired before use. Many accidents are caused by poorly maintained power tools.

**f.** Keep cutting tools sharp and clean. Properly maintained cutting tools with sharp cutting edges are less likely to bind and are easier to control.

**g.** Use the power tool, accessories and tool bits etc. in accordance with these instructions, taking into account the working conditions and the work to be performed. Use of the power tool for operations different from those intended could result in a hazardous situation.

## **5. Battery tool use and care**

**a.** Recharge only with the charger specified by the manufacturer. A charger that is suitable for one type of battery pack may create a risk of fire when used with another battery pack.

**b.** Use power tools only with specifically designated battery packs. Use of any other battery packs may create a risk of injury and fire.

**c.** When battery pack is not in use, keep it away from other metal objects, like paper clips, coins, keys, nails, screws or other small metal objects that can make a connection from one terminal to another. Shorting the battery terminals together may cause burns or a fire.

**d.** Under abusive conditions, liquid may be ejected from the battery; avoid contact. If contact accidentally occurs, flush with water. If liquid contacts eyes, additionally seek medical help. Liquid ejected from the battery may cause irritation or burns.

**e.** Have your power tool serviced by a qualified repair person using only identical replacement parts. This will ensure that the safety of the power tool is maintained.



**f.** Always push the gear selector and turn the operating mode selector switch through to the stop. Otherwise, the machine can become damaged.

## Service

Have your power tool serviced by a qualified repair person using only identical replacement parts. This will ensure that the safety of the power tool is maintained.

## 6. Symbols

a. Some of the following symbols may appear on this product. Study these symbols and learn their meanings. Proper interpretation of these symbols will allow for more efficient and safer operation of this product.

SYMBOL	DESCRIPTION
	Read the manual before set-up and/or use.
	Do not dispose with household waste.
	Conforms to relevant safety standards.

## Technical Data:

Voltage:	20V $\overline{\text{---}}$
No Load Speed:	3150 min <sup>-1</sup>
Blade Size:	Ø 3-1/2"
Arbor Size:	3/8"
Max. cutting depth:	Wood: 1-1/8" Alum: 1/8" Tile: 1/3"

### Includes:

- 1.Saw Blade
- 2.Base Plate
- 3.Dust Extraction Port
- 4.Upper Blade Guide
- 5.Rip Guide
6. Vacuum Adaptor
- 7.Blade Wrench
- 8.Rip Guide Locking Screw
- 9.Blade Bolt & Washer
10. Lock Off Button
- 11.On/Off Switch
12. Depth Guide Bracket
- 13.Depth Dial
14. Spindle Lock Button
15. Laser

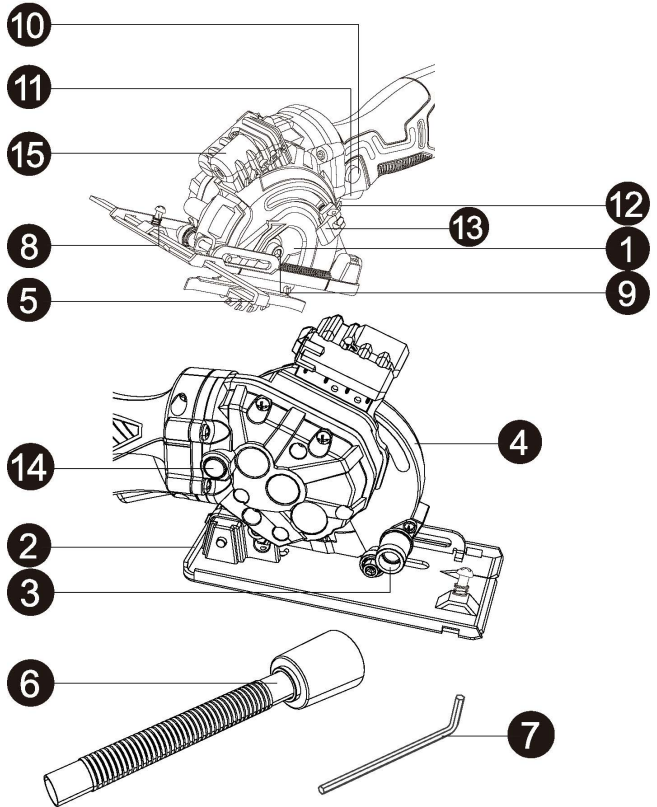

## Assembly:

### Mounting the Saw Blade

- a. Clean the saw blade and all clamping parts to be assembled.
- b. Press the Lock off button, then adjust the base plate to the maximum cutting depth and keep it there.
- c. Put the saw blade on the spindle. The cutting direction of the saw blade (or arrow) and the rotation direction of the guard must correspond.
- d. Restore the base plate to its original position.
- e. Place blade bolt and washer on the saw blade successively and align the aperture.
- f. Tighten the fastening bolts anti-clockwise with a allen wrench.

**NOTE:** Press the Spindle Lock Button and turn the allen wrench counter clockwise to check whether the bolts and saw blades are tightened.

### Removal of the Saw Blade

- a. Press the Spindle Lock Button and keep pressing.
- b. Loosen bolt clockwise with allen wrench, remove blade bolt and washer.
- c. Adjust the base plate to the maximum cutting depth.
- d. Remove the saw blade from the machine.

**NOTE:** When adjusting the base, press the Lock off button first and hold.





### Operation:

#### Install the Rip Guide

To install the rip guide on the machine, perform the following steps.

- Remove battery from your plunge saw.
- Insert the rip guide through all three slots on the base plate at the front of the saw, starting with slot in the left side edge of the base.
- Slide the left guide through the slots until it extends out the right side of the base plate.
- Adjust the rip guide for the desired width of cut and then securely tighten the rip guide locking screw.

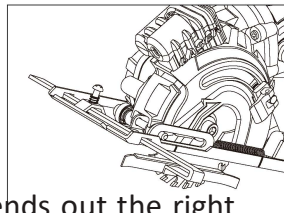

#### Switch On/Off

**NOTE:** Before turning on/ off the switch, check the saw blade for proper installation and smooth operation.

To start the machine, press the Lock off button and press the trigger.

To stop the machine, release the trigger, and then the machine stops.

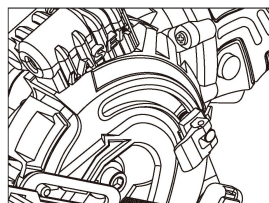

#### Depth adjustment

Before cutting, move the depth guide lever on the depth guide bracket to the desired position and tighten it.

#### Laser Function:

When you make the line of the cut on the work piece, the laser can help you get better alignment.

- Make sure line of the cut on the work piece.
- Adjust the angle of cut as required
- Plug in the machine and start the motor
- When the blade is at its maximum speed (approximately 2 seconds)
- Align the beam with the mark on the work piece

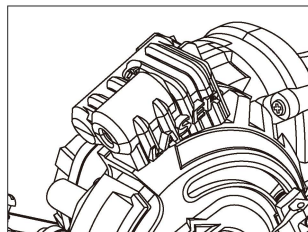

## Maintenance:



**WARNING:** Before any work on the machine itself, remove the battery pack from the drill.

1. Inspect bolts periodically. If the bolts loosen, tighten them immediately, or will result in serious accident.
2. Inspect tool cords periodically. If damaged, have repaired at your nearest Authorised Service Center.
3. Keep the vents clean. Clean all parts of the tool, clean dust periodically. To prevent debris from entry.
4. All service **MUST** only be performed by Authorised Service Center. **ALWAYS** use only accessories that are recommended for this tool.
5. Cleaning. Use clean cloths and mild soap to remove dirt, dust, etc.



## Service:

1. In case of guarantee repair or purchase of replacement parts, always contact the qualified service center. Please provide with the appropriate service card and invoice.
2. It is outside the scope of the guarantee when the tool has normal wear and tear, has been overload or improper use of the tool.

## CE DECLARATION OF CONFORMITY

### **TOOLSAVE**

Unit C, Manders Ind. Est.,  
Old Heath Road, Wolverhampton,  
WV1 2RP.

Tel: 01902 450 470

**Declares that the Mini Plunge Saw (LPS89L)  
Is in compliance with the regulations included in the  
Directives:2006/42/EC**

## EC DECLARATION OF CONFORMITY

Certificate for EC-type examination delivered by Intertek Testing Services  
Ltd.,Shanghai,ETL Semko Building No.86,1198 Qinzhou Road(North),Caohejing

Development Zone,Shanghai 200233,China. (Verification No.:150300747SHA-V1)

Person who declares: Bill Evans



**13.04.2021**

**The  
Director**





# LUMBER

# JACK

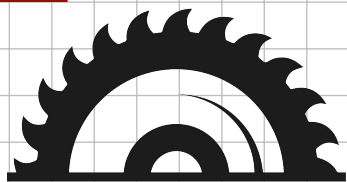

UNIT C  
MANDERS INDUSTRIAL ESTATE,  
OLD HEATH ROAD,  
WOLVERHAMPTON

[www.Lumberjacktools.co.uk](http://www.Lumberjacktools.co.uk)